

GRUPUL LICHTGITTER

GI-RO gratare rafturi

LICHTGITTER RO – PRODUCĂTOR GRĂTARE METALICE,
SCĂRI METALICE

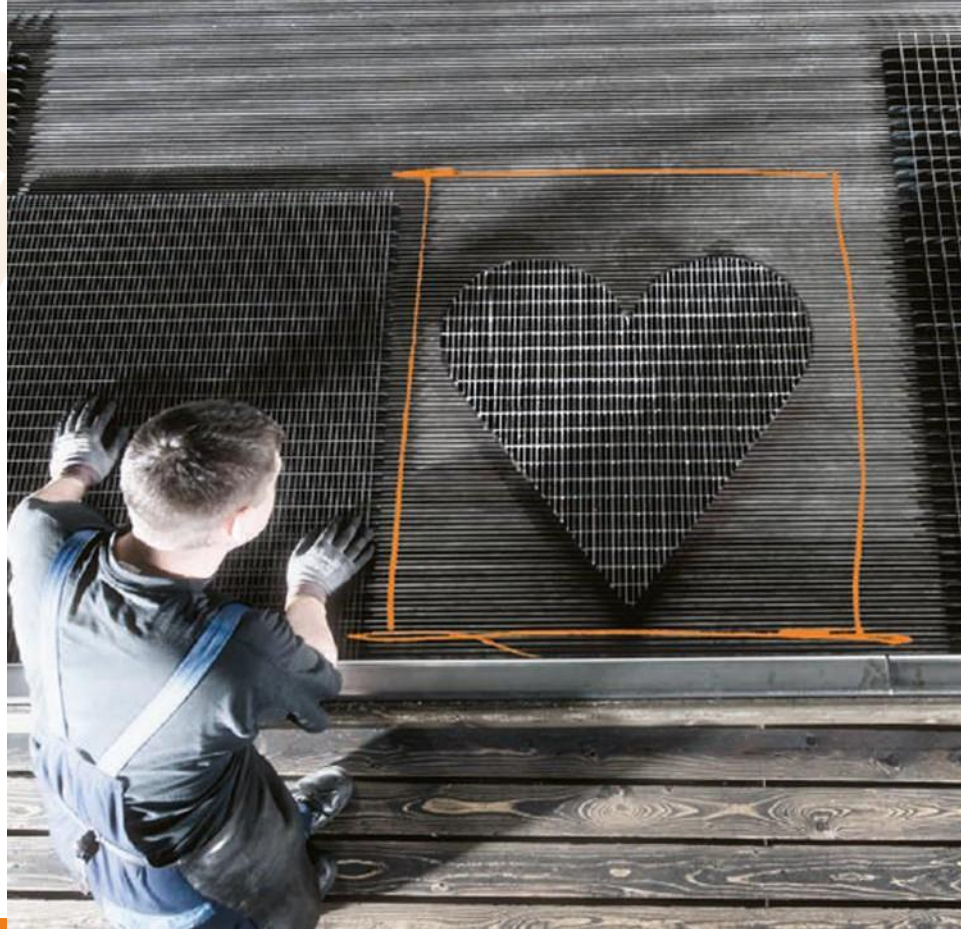

June, 1st, 2023



CUPRINS:

1. GRATARE DEPOZITARE PALETI
2. EXEMPLE DE PROIECTE
3. RAFT CU GRINDA IN CONSOLA
4. VARIANTE DE INCARCARE



GRATARE DEPOZITARE PALETI - RAFT

GRATARE INTRE GRINZI



Folosite in special pentru:

- Incarcari de pana la aprox. 1.500 kg/m² (in functie de cerintele sistemului de rafturi)
- Toate tipurile de ambalari (Paleti, Cutii, dimensiuni speciale)
- Toate tipurile de rafturi pentru paleti

Avantaje:

- Inaltime mica de instalare – nu se pierde inaltime de depozitare, Risc mic de distrugere prin pozitionarea intre traversele raftului
- Instalare simpla si rapida
- Avantajoase ca pret fata de gratarele pozitionate pe grinda

GRATARE DEPOZITARE PALETI - RAFT

GRATARE POZITIONATE PE GRINDA

Folosite in special pentru:

- Incarcari mai ridicate(>1.500 kg/m²)
- Toate tipurile de ambalari (Paleti, Cutii, dimensiuni speciale)
- Rafturi duble

Avantaje:

- Potrivite pentru incarcari ridicate
- Instalare simpla si rapida
- Fara interferente pe contur cu sistemele de stingere a incendiilor

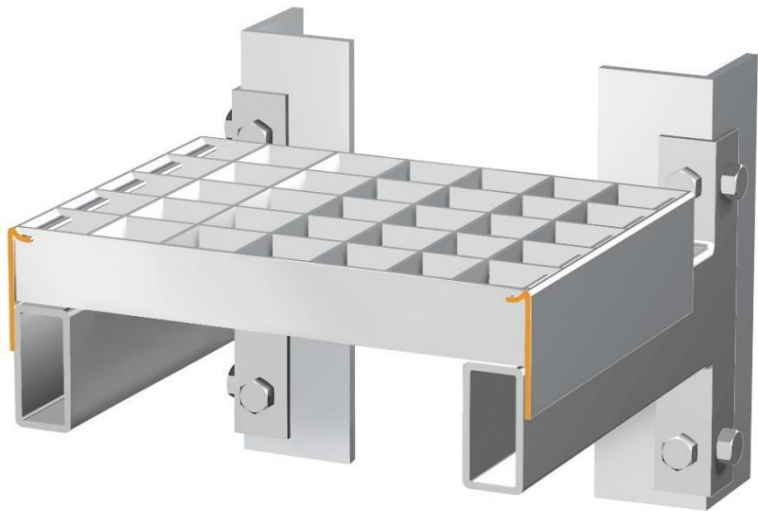

GRATARE DEPOZITARE PALETI - RAFT

Variante extinse

Protectie la impingerea incarcaturii

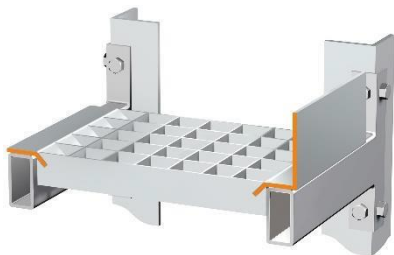

- Protectia echipamentelor (ex. Sistemul de Sprinklere)
- Protectia in cazul erorilor operatorului

Profil U

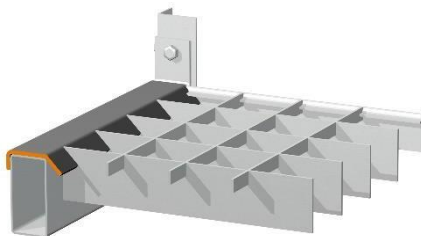

- Stabilizarea traverselor pentru lungimi > cca. 3600 mm

Deflectoare de foc



- Asigura declansarea prompta a sistemelor de sprinklere in caz de incendiu
- Evitarea efectului de cos de fum

GRATARE DEPOZITARE PALETI - RAFT

DIVERSE MODULE

Nervura portanta: 995 mm

Nervura secundara: 890 mm

Bordura: Vario-Profil

Potrivit pentru latimi de rafturi uzuale

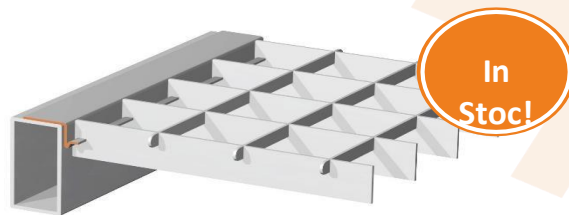

VERSIUNEA STANDARD

CU Bordura pe directia nervurii portante

Incarcare	Nervura portanta	Dim. ochi
500 kg/m ²	35/1,7 mm S355JR	88 x 44,44 mm
1000 kg/m ²	40/1,7 mm S355JR	66 x 44,44 mm

VERSIUNEA USOARA

FARA Bordura pe directia nervurii portante

Incarcare	Nervura portanta	Dim. ochi
350 kg/m ²	35/1,7 mm S355JR	121 x 55,55 mm
1000 kg/m ²	46/1,7 mm S355JR	99 x 55,55 mm

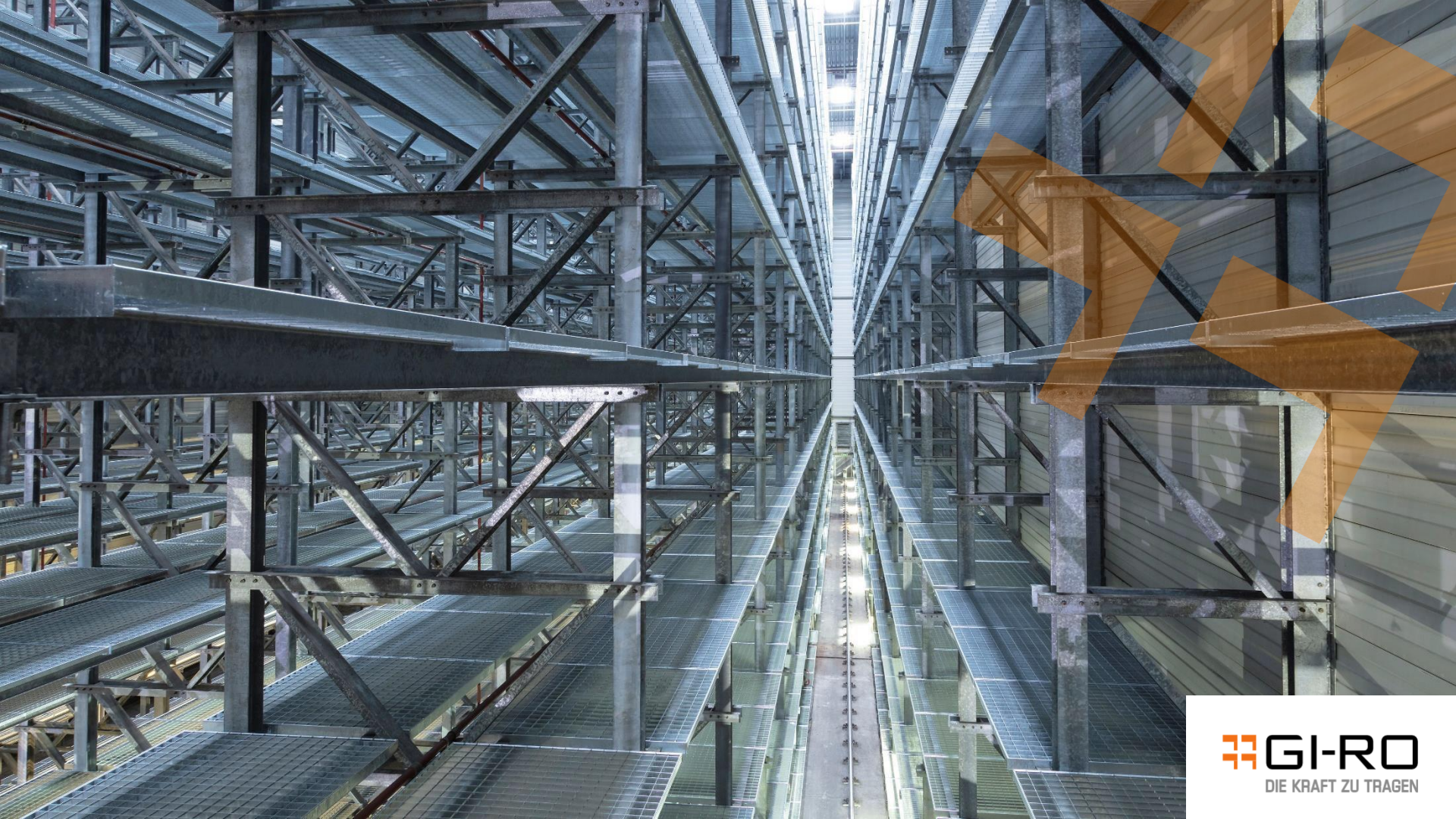

EXEMPLE DE PROIECTE

PROIECT: SCHWARZWALD

Hala existenta

Conversia in **scurt timp** pentru
14.000 zone depozitare pentru
diferite containere
standard

30 m inaltime raft

Profil IPE, **latime mare raft**,
consola

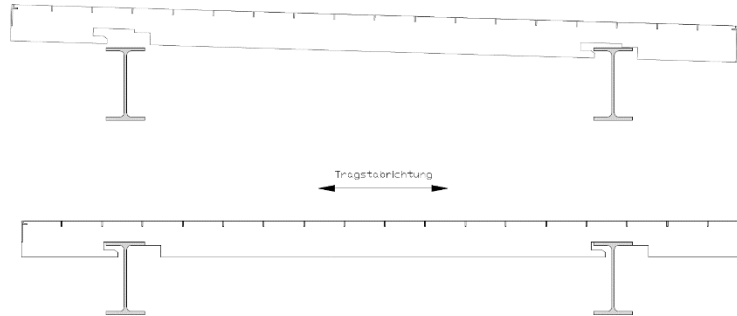
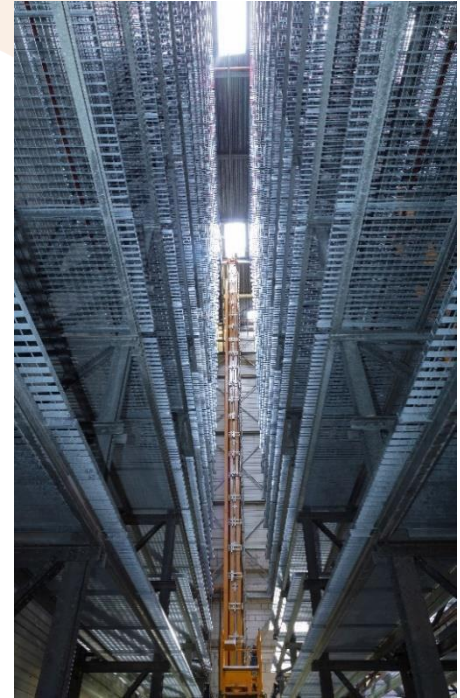
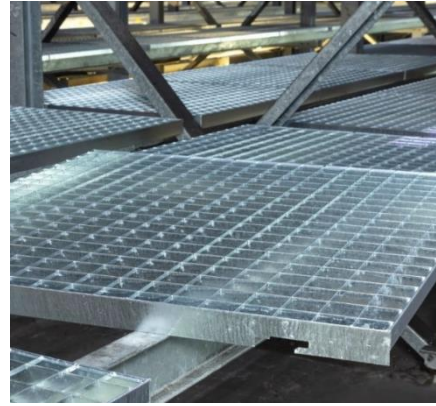

EXEMPLE DE PROIECTE

PROIECT: SCHWABEN

6.500 m² supr. depozitare

10.000 spatii de depozitare

ptr. paleti

Setare **precisa a cerintelor**
specifice

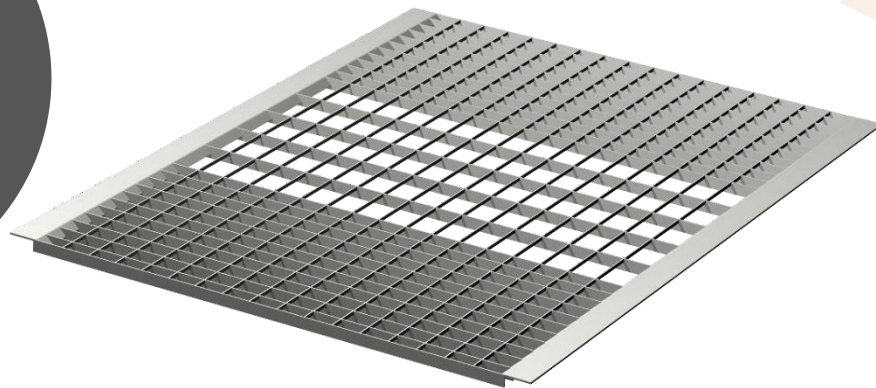

EXEMPLE DE PROIECTE

PROIECT: SLOVENIA

2.400 Spatii dep.paleti

Diferite Latimi de raft pana la
6.500 mm

Locatia proiectului este

In zona seismica

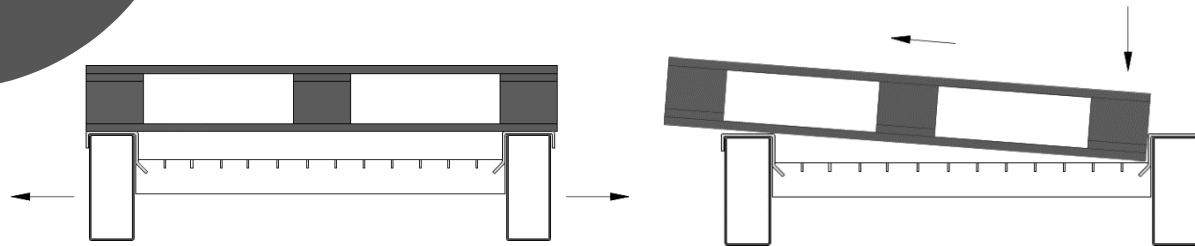
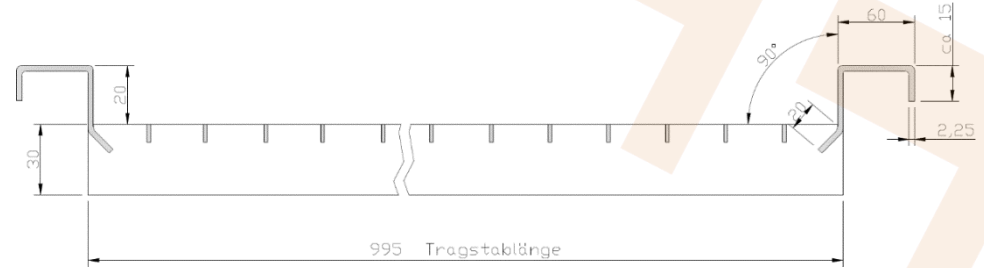

Securizeaza paletul in caz de cutremur



GRATARE PENTRU RAFTURI IN CONSOLA

GRATARE ASEZATE PE GRINDA

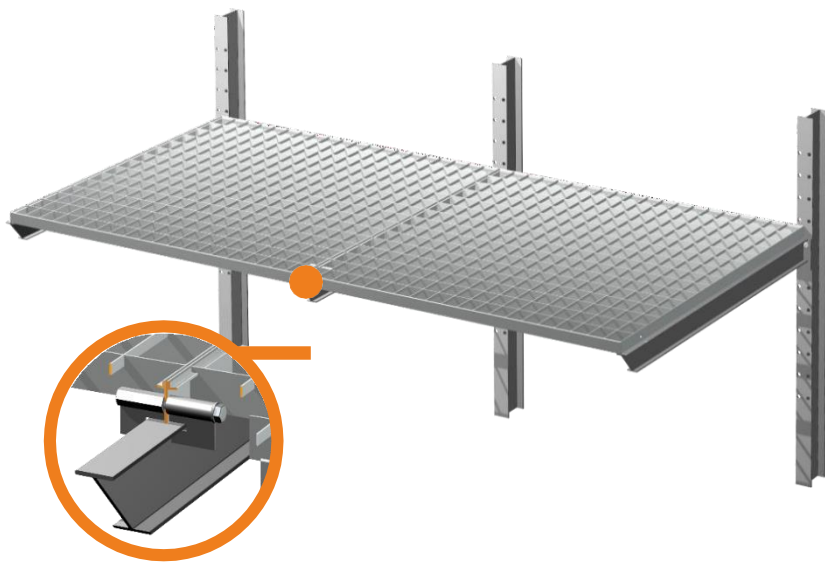

In special destinate pentru:

- Toate tipurile de rafturi in consola
- De la incarcari mici pana la incarcari foarte mari

Avantaje:

- Sistem integrat care se potriveste perfect
- Prindere durabila – fara slabire in exploatare
- Fara interferente cu elemente de prindere a gratarului pe suprafata (ex.: suruburi sau alte elem. de fixare)

Video:



GRATARE PENTRU RAFTURI IN CONSOLA

GRATARE INTRE GRINZI

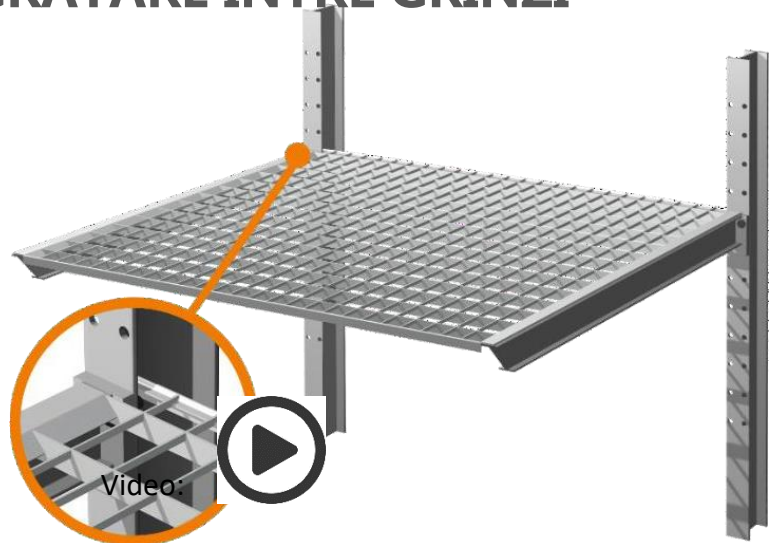

In special potrivite pentru:

- Proiecte mari cu rafturi in consola de acelasi tip
- Incarcari usoare spre medii

Avantaje:

- Fixare pe pozitie
- Asamblare rapida si ieftina
- Fara pierderi din inaltimea de stocare a raftului

:



VARIANTE DE INCARCARI

TIPURI DE INCARCARI

Tipul de incarcare se va considera in functie de greutatea depozitata si de pozitia acesteia pe raft.

Incarcare uniform distribuita:

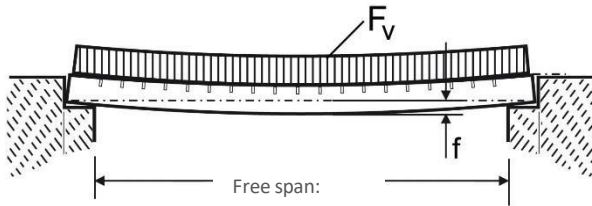

Incarcare uniform distribuita
incarcare per mp sau per
nivel

Incarcare concentrata:

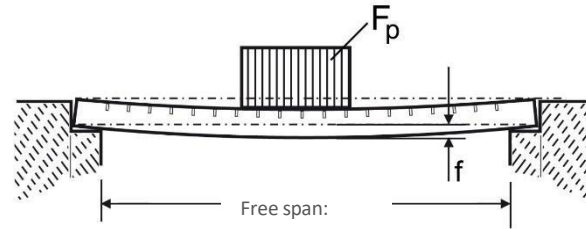

Incarcarea este transferata gratarului
intr-un mod concentrat pe o suprafata
mica de incarcare

VARIANTE DE INCARCARI

MOD DE IMPACHETARE

Euro-Palet



Pozitii de depozitare

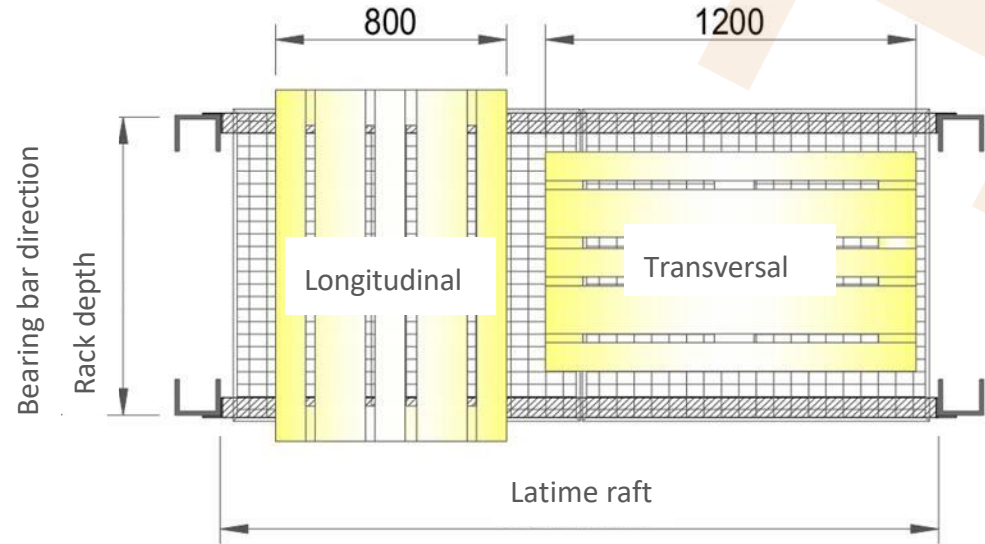

VARIANTE DE INCARCARI

MOD DE IMPACHETARE

Euro grid box



Pozitii de depozitare:

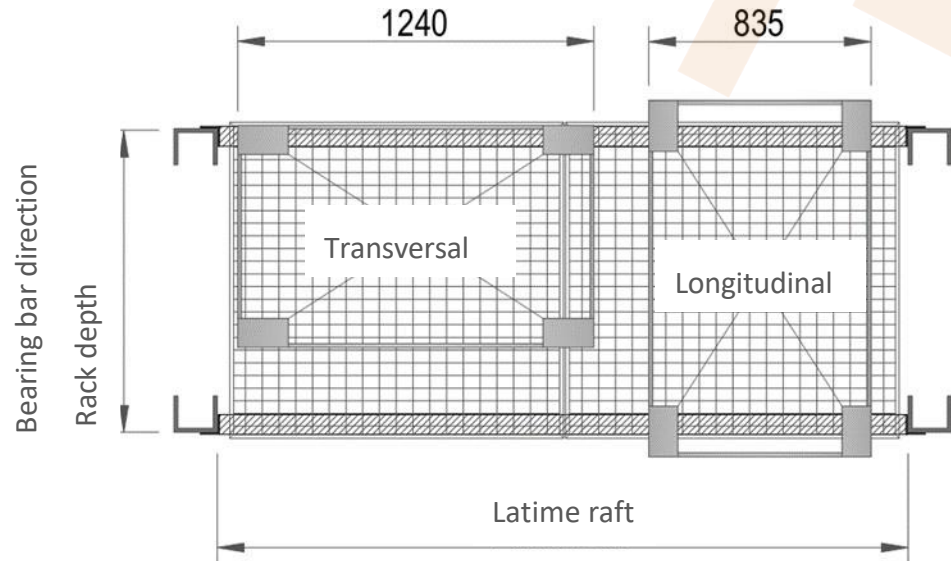

VARIANTE DE INCARCARI

MOD DE IMPACHETARE

Euro-Gitterbox

Amprenta piciorului (suprafata de incarcare), transversala pe directia nervurilor portante, influenteaza numarul nervurilor portante.

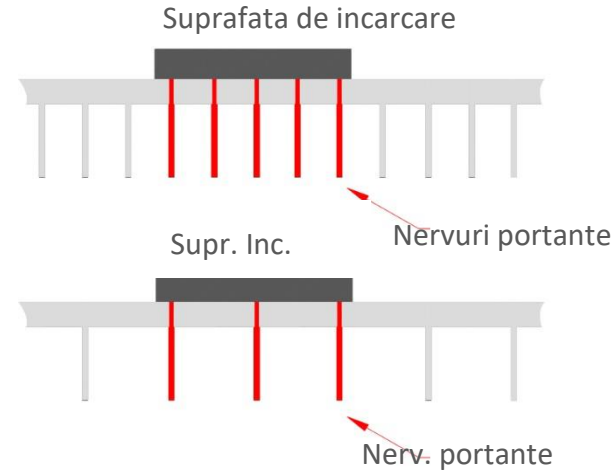
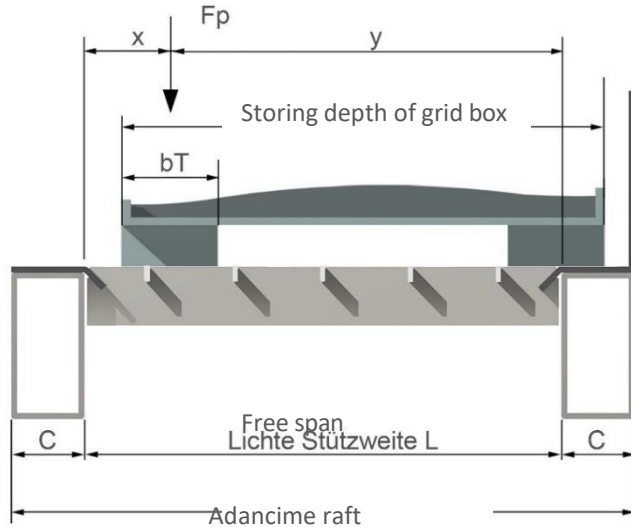



VA MULTUMIM PENTRU ATENTIE

 **GI-RO**
DIE KRAFT ZU TRAGEN

